



Low voltage AC drives

ABB general machinery drives ACS355 0.37 to 22 kW / 0.5 to 30 hp Catalog

Two ways to select your drive

Choice 1: Simply contact your local ABB drives sales office and let them know what you want. Use page 3 as a reference section for more information.

OR

Choice 2: Build up your own ordering code using the simple 7-step approach below. Each step is accompanied by a reference to a page that is filled with useful information.

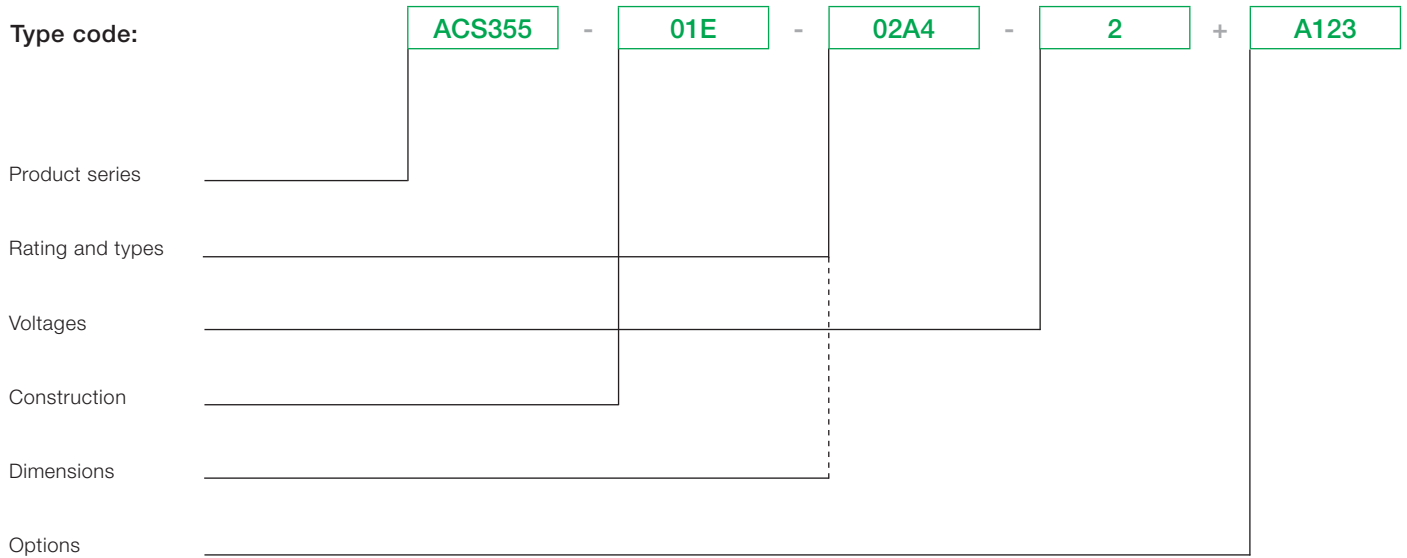

Contents

ABB general machinery drives, ACS355

ABB general machinery drives	4
Features, advantages and benefits	4
Ratings and types	6
Type code	6
Voltages	6
Construction	6
Technical data	7
Dimensions and weights	8
Cabinet-mounted drives (IP20 UL Open)	8
Wall-mounted drives (NEMA 1/UL Type 1)	8
Wall-mounted drives (IP66/IP67/UL Type 4X)	8
Cooling and fuses	9
Control connections	10
Connection examples	10
Options	11
How to select options	11
User interfaces	12
Machine interfaces	13
Extension modules	13
Protection and installation	13
DriveWindow Light 2	14
FlashDrop tool	15
Brake resistors	15
Input and output chokes	16
EMC filters	17
Low leakage current filters	17
Services	18

ABB general machinery drives

ACS355 - 01E - 02A4 - 2 + A123

ABB general machinery drives

The ABB general machinery drives are designed to be the fastest drives to install, parameter-set and commission. They are highly compact and cost effective. Equipped with cutting-edge intelligence and safety capability the drives are designed specifically to meet the production and performance needs of system integrators, original equipment manufacturers (OEMs) and panel builders, as well as the requirements of end users in a broad range of applications.

Applications

ABB general machinery drives are designed to meet the requirements of an extensive range of machinery applications. The drives are ideal for food and beverage, material handling, lifting, textile, printing, rubber and plastics, and woodworking applications.

Highlights

- Exceptionally compact drives and uniform design
- Quick commissioning with application macros and panel assistants
- Safe Torque-Off function (SIL3) as standard
- Sensorless vector control
- Built-in braking chopper
- High protection class variants for harsh environments

Feature	Advantage	Benefit
Worldwide availability and service	Drives are available worldwide and permanently stocked in four regions. Dedicated global service and support network that is one of the largest in the industry.	Fast and reliable delivery with dedicated support to any country in the world.
Broadest power range in its class from 0.37 to 22 kW	Drive series covers all the typical needs of machine builders with a single family of machinery drive.	Cost savings as machine builders need to choose only one drive series.
Exceptionally compact drives and uniform design	Drive has the highest power density in its class at 2.8 kW/dm ³ . All frame sizes share the same depth and height facilitating multiple drive solutions and cabinet installations.	Space savings in restricted spaces.
Safe Torque-Off function (SIL3) as standard	Built-in and certified function that is used for prevention of an unexpected start-up and other stopping related functions.	Reduces the need for external safety components Helps machine builders to fulfill the requirements of Machinery Directive 2006/42/EC.
Sequence programming	Simple drive control logic, with up to eight pre-set sequences of operations, is created in minutes with built-in sequence programming.	Reduces the need for external PLC components.
Application macros and control panel's assistants	Pre-defined I/O configurations containing macros such as 3-wire, PID-control and motor potentiometer macro. Different assistants help set parameters for different functions such as drive start-up, motor set-up or PID control.	Enables quick commissioning of a drive.
FlashDrop tool	A pre-defined machine parameter set, from selection of up to 20, can be downloaded in seconds to a drive without powering the drive. The FlashDrop tool is easy to use and no specialized drives knowledge is required.	Fast, easy and reliable pre-configuration of drives for high-volume machine builders.
Speed compensated stop	A feature for applications that require precision stopping that is independent of variations in process speed.	Improved production flow and cost saving of a built-in feature.
Product variant for demanding environments with IP66/67/UL Type 4X protection classes	No need to design special enclosure for application that requires a high ingress protection. NSF certified.	Time and cost savings.
Sensorless vector control	Accurate motor control without a feedback device.	Cost saving of a reduced component.

ABB general machinery drives

ACS355 - 01E - 02A4 - 2 + B063

High protection class drive

A range of ABB general machinery drives with IP66, IP67 and UL Type 4X protection classes is designed to excel in the harshest and most demanding of conditions.

Designed for the food and beverage, textile, ceramics, pulp and paper and water and waste water industries, the drives are suitable for screws, mixers, pumps, fans and conveyers especially where the machine is exposed to dust, moisture and cleaning chemicals. The heat sink's cooling fins are completely open from top to bottom, which allows easy washing to ensure no dirt adheres to the surfaces. A user control panel housed within a plastic window is designed to resist moist and dusty atmospheres. Furthermore, the cooling fan is located inside the drive, thereby eliminating the need for an external cooling fan and the subsequent maintenance of external moving parts. The wall mounted drive can be located close to the process and the operator. The drive features the assistant control panel as standard.

The drive's hygienic design and use of materials meeting current hygiene standards, means that the drive traps no bacteria and can withstand frequent washing. The drive is certified by NSF.

Mains connection, high protection class drive

Voltage and power range	3-phase, 200 to 240 V ± 10% 0.37 to 4 kW (0.5 to 5 hp) 3-phase, 380 to 480 V ± 10% 0.37 to 7.5 kW (0.5 to 10 hp)
--------------------------------	---

Environmental limits, high protection class drive

Ambient temperature	-10 to 40 °C (14 to 104 °F), no frost allowed
Degree of protection	IP66/IP67/UL Type 4X, indoor use only IP69K with compatible cable glands

Product compliance, high protection class drive

Low Voltage Directive 73/23/EEC with supplements
Machinery Directive 98/37/EC
EMC Directive 89/336/EEC with supplements
Quality assurance system ISO 9001
Environmental system ISO 14001
UL, cUL, CE, C-Tick and GOST R approvals
RoHS compliant
NSF Certified
DIN40050-9 (IP69K)



Ratings and types

ACS355 - 01E - 02A4 - 2 + A123

Type code

This is the unique reference number (shown above and in column 4, right) that clearly identifies your drive by power rating and frame size. Once you have selected the type code, the frame size (column 5) can be used to determine the drive dimensions, shown on the next page.

Voltages

ACS355 is available in two voltage ranges:

2 = 200 to 240 V

4 = 380 to 480 V

Insert either “2” or “4”, depending on your chosen voltage, into the type code shown above.

Ratings IP20 / UL Open Type / NEMA 1 option			Type code	Frame size
P_N [kW]	P_N [hp]	I_{2N} [A]		
1-phase supply voltage 200 to 240 V units				
0.37	0.5	2.4	ACS355-01X-02A4-2	R0
0.75	1.0	4.7	ACS355-01X-04A7-2	R1
1.1	1.5	6.7	ACS355-01X-06A7-2	R1
1.5	2.0	7.5	ACS355-01X-07A5-2	R2
2.2	3.0	9.8	ACS355-01X-09A8-2	R2
3-phase supply voltage 200 to 240 V units				
0.37	0.5	2.4	ACS355-03X-02A4-2	R0
0.55	0.75	3.5	ACS355-03X-03A5-2	R0
0.75	1.0	4.7	ACS355-03X-04A7-2	R1
1.1	1.5	6.7	ACS355-03X-06A7-2	R1
1.5	2.0	7.5	ACS355-03X-07A5-2	R1
2.2	3.0	9.8	ACS355-03X-09A8-2	R2
3.0	4.0	13.3	ACS355-03X-13A3-2	R2
4.0	5.0	17.6	ACS355-03X-17A6-2	R2
5.5	7.5	24.4	ACS355-03X-24A4-2	R3
7.5	10.0	31.0	ACS355-03X-31A0-2	R4
11.0	15.0	46.2	ACS355-03X-46A2-2	R4
3-phase supply voltage 380 to 480 V units				
0.37	0.5	1.2	ACS355-03X-01A2-4	R0
0.55	0.75	1.9	ACS355-03X-01A9-4	R0
0.75	1.0	2.4	ACS355-03X-02A4-4	R1
1.1	1.5	3.3	ACS355-03X-03A3-4	R1
1.5	2.0	4.1	ACS355-03X-04A1-4	R1
2.2	3.0	5.6	ACS355-03X-05A6-4	R1
3.0	4.0	7.3	ACS355-03X-07A3-4	R1
4.0	5.0	8.8	ACS355-03X-08A8-4	R1
5.5	7.5	12.5	ACS355-03X-12A5-4	R3
7.5	10.0	15.6	ACS355-03X-15A6-4	R3
11.0	15.0	23.1	ACS355-03X-23A1-4	R3
15.0	20.0	31.0	ACS355-03X-31A0-4	R4
18.5	25.0	38.0	ACS355-03X-38A0-4	R4
22.0	30.0	44.0	ACS355-03X-44A0-4	R4

Construction

“01E” within the type code (shown above) varies depending on the drive phase and EMC filtering. Choose below the one you need.

01 = 1-phase

03 = 3-phase

E = EMC filter connected, 50 Hz frequency

U = EMC filter disconnected, 60 Hz frequency

(In case the filter is required it can easily be connected)

B063 = IP66/IP67/UL Type 4X enclosure

Ratings IP66/IP67/UL Type 4X			Type code	Frame size
P_N [kW]	P_N [hp]	I_{2N} [A]		
3-phase supply voltage 200 to 240 V units				
0.37	0.5	2.4	ACS355-03X-02A4-2 + B063	R1
0.55	0.75	3.5	ACS355-03X-03A5-2 + B063	R1
0.75	1.0	4.7	ACS355-03X-04A7-2 + B063	R1
1.1	1.5	6.7	ACS355-03X-06A7-2 + B063	R1
1.5	2.0	7.5	ACS355-03X-07A5-2 + B063	R1
2.2	3.0	9.8	ACS355-03X-09A8-2 + B063	R3
3.0	4.0	13.3	ACS355-03X-13A3-2 + B063	R3
4.0	5.0	17.6	ACS355-03X-17A6-2 + B063	R3
3-phase supply voltage 380 to 480 V units				
0.37	0.5	1.2	ACS355-03X-01A2-4 + B063	R1
0.55	0.75	1.9	ACS355-03X-01A9-4 + B063	R1
0.75	1.0	2.4	ACS355-03X-02A4-4 + B063	R1
1.1	1.5	3.3	ACS355-03X-03A3-4 + B063	R1
1.5	2.0	4.1	ACS355-03X-04A1-4 + B063	R1
2.2	3.0	5.6	ACS355-03X-05A6-4 + B063	R1
3.0	4.0	7.3	ACS355-03X-07A3-4 + B063	R1
4.0	5.0	8.8	ACS355-03X-08A8-4 + B063	R1
5.5	7.5	12.5	ACS355-03X-12A5-4 + B063	R3
7.5	10.0	15.6	ACS355-03X-15A6-4 + B063	R3

X within the type code stands for E or U.

Technical data

ACS355

01E

02A4

2

A123

Mains connection

Voltage and power range	1-phase, 200 to 240 V \pm 10% 0.37 to 2.2 kW (0.5 to 3 hp) 3-phase, 200 to 240 V \pm 10% 0.37 to 11 kW (0.5 to 15 hp) 3-phase, 380 to 480 V \pm 10% 0.37 to 22 kW (0.5 to 30 hp)
Frequency	48 to 63 Hz

Motor connection

Voltage	3-phase, from 0 to U_{SUPPLY}
Frequency	0 to 600 Hz
Continuous loading capability (constant torque at a max. ambient temperature of 40 °C)	Rated output current I_{2N}
Overload capacity (at a max. ambient temperature of 40 °C)	1.5 x I_{2N} for 1 minute every 10 minutes At start 1.8 x I_{2N} for 2 s
Switching frequency Selectable	Default 4 kHz 4 to 16 kHz with 4 kHz steps
Acceleration time	0.1 to 1800 s
Deceleration time	0.1 to 1800 s
Braking	Built-in brake chopper as standard
Speed control Static accuracy Dynamic accuracy	20% of motor nominal slip < 1% s with 100% torque step
Torque control Torque step rise time Non-linearity	< 10ms with nominal torque \pm 5% with nominal torque

Environmental limits

Ambient temperature	-10 to 40 °C (14 to 104 °F), no frost allowed 50 °C (122 °F) with 10% derating
Altitude	Rated current available at 0 to 1000 m (0 to 3281 ft) reduced by 1% per 100 m (328 ft) over 1000 to 2000 m (3281 to 6562 ft)
Relative humidity	Lower than 95% (without condensation)
Degree of protection	IP20 / optional NEMA 1/ UL type 1 enclosure IP66/IP67/UL Type 4X as an option up to 7.5 kW, IP69K available for IP66/IP67 variant with compatible cable glands
Enclosure colour	NCS 1502-Y, RAL 9002, PMS 420 C
Contamination levels	IEC721-3-3 No conductive dust allowed Transportation Class 1C2 (chemical gases) Class 1S2 (solid particles) Storage Class 2C2 (chemical gases) Class 2S2 (solid particles) Operation Class 3C2 (chemical gases) Class 3S2 (solid particles)

Product compliance

Low Voltage Directive 2006/95/EC
Machinery Directive 2006/42/EC
EMC Directive 2004/108/EC
Quality assurance system ISO 9001
Environmental system ISO 14001
UL, cUL, CE, C-Tick and GOST R approvals
RoHS compliant

Programmable control connections

Two analog inputs Voltage signal Unipolar Bipolar Current signal Unipolar Bipolar Potentiometer reference value Resolution Accuracy	0 (2) to 10 V, $R_{in} > 312 \text{ k}\Omega$ -10 to 10 V, $R_{in} > 312 \text{ k}\Omega$ 0 (4) to 20 mA, $R_{in} = 100 \Omega$ -20 to 20 mA, $R_{in} = 100 \Omega$ 10 V \pm 1% max. 10 mA, $R < 10 \text{ k}\Omega$ 0.1% \pm 2%
One analog output	0 (4) to 20 mA, load < 500 Ω
Auxiliary voltage	24 V DC \pm 10%, max. 200 mA
Five digital inputs Input impedance	12 to 24 V, PNP and NPN, programmable DI5 0 to 16 kHz pulse train 2.4 k Ω
One relay output Type Maximum switching voltage Maximum switching current Maximum continuous current	NO + NC 250 V AC/30 V DC 0.5 A/30 V DC; 5 A/230 V AC 2 A rms
One digital output Type Maximum switching voltage Maximum switching current Frequency Resolution Accuracy	Transistor output 30 V DC 100 mA/30 V DC, short circuit protected 10 Hz to 16 kHz 1 Hz 0.2%

Serial communication

Fieldbuses Refresh rate	Plug-in type < 10 ms (between drive and fieldbus module)
PROFIBUS DP	9-pin D-connector, up to 12 Mbit/s baud rate
DeviceNet	5-pin screw type connector, up to 500 kbit/s baud rate
CANopen	9-pin D-connector, up to 1 Mbit/s
ModBus	4-pin screw type connector, up to 115 kbit/s baud rate
Ethernet	RJ-45 connector, 10/100 Mbit/s baud rate
EtherCat	2 pcs RJ-45 connectors, 100 Mbit/s baud rate
LonWorks	3-pin screw type connector, up to 78 kbit/s baud rate

Chokes

AC input chokes	External option For reducing THD in partial loads and to comply with EN/IEC 61000-3-12.
AC output chokes	External option To achieve longer motor cables

Dimensions and weights

ACS355 - 01E - 02A4 - 2 + A123

Cabinet-mounted drives (IP20 UL Open)

Frame size	IP20 UL Open						
	H1 mm	H2 mm	H3 mm	W mm	D1 mm	D2 mm	Weight kg
R0	169	202	239	70	161	187	1.2
R1	169	202	239	70	161	187	1.2
R2	169	202	239	105	165	191	1.5
R3	169	202	236	169	169	195	2.5
R4	181	202	244	260	169	195	4.4

H1 = Height without fastenings and clamping plate
 H2 = Height with fastenings but without clamping plate
 H3 = Height with fastenings and clamping plate
 W = Width
 D1 = Standard depth
 D2 = Depth with MREL, MPOW or MTAC option

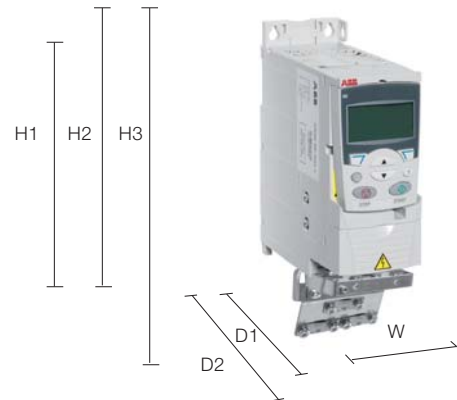

Wall-mounted drives (NEMA 1/UL Type 1)

Frame size	NEMA 1/UL Type 1					
	H4 mm	H5 mm	W mm	D1 mm	D2 mm	Weight kg
R0	257	280	70	169	187	1.6
R1	257	280	70	169	187	1.6
R2	257	282	105	169	191	1.9
R3	260	299	169	177	195	3.1
R4	270	320	260	177	195	5.0

H4 = Height with fastenings and NEMA 1 connection box
 H5 = Height with fastenings, NEMA 1 connection box and hood
 W = Width
 D1 = Standard depth
 D2 = Depth with MREL, MPOW or MTAC option



Wall-mounted drives (IP66/IP67/UL Type 4X)

Frame size	IP66/IP67/UL Type 4X			
	H mm	W mm	D1 mm	Weight kg
R1	305	195	281	7.7
R3	436	246	277	13

H = Height
 W = Width
 D1 = Standard depth



Cooling and fuses

Cooling

ACS355 is fitted with cooling fans as standard. The cooling air must be free from corrosive substances and must not be above the maximum ambient temperature of 40 °C (50 °C with derating). Heat dissipation from IP66/IP67/UL Type 4X drive equals to the IP20 UL Open values. For more specific limits see the Technical specification - Environmental limits in this catalog.

Cooling air flow

Type code	Frame size	Heat dissipation		Air flow	
		[W]	BTU/hr ¹⁾	m ³ /h	ft ³ /min
1-phase supply voltage 200 to 240 V units					
ACS355-01X-02A4-2	R0	48	163	- ²⁾	- ²⁾
ACS355-01X-04A7-2	R1	72	247	24	14
ACS355-01X-06A7-2	R1	97	333	24	14
ACS355-01X-07A5-2	R2	101	343	21	12
ACS355-01X-09A8-2	R2	124	422	21	12
3-phase supply voltage 200 to 240 V units					
ACS355-03X-02A4-2	R0	42	142	- ²⁾	- ²⁾
ACS355-03X-03A5-2	R0	54	183	- ²⁾	- ²⁾
ACS355-03X-04A7-2	R1	64	220	24	14
ACS355-03X-06A7-2	R1	86	295	24	14
ACS355-03X-07A5-2	R1	88	302	21	12
ACS355-03X-09A8-2	R2	111	377	21	12
ACS355-03X-13A3-2	R2	140	476	52	31
ACS355-03X-17A6-2	R2	180	613	52	31
ACS355-03X-24A4-2	R3	285	975	71	42
ACS355-03X-31A0-2	R4	328	1119	96	57
ACS355-03X-46A2-2	R4	488	1666	96	57
3-phase supply voltage 380 to 480 V units					
ACS355-03X-01A2-4	R0	35	121	- ²⁾	- ²⁾
ACS355-03X-01A9-4	R0	40	138	- ²⁾	- ²⁾
ACS355-03X-02A4-4	R1	50	170	13	8
ACS355-03X-03A3-4	R1	60	204	13	8
ACS355-03X-04A1-4	R1	69	235	13	8
ACS355-03X-05A6-4	R1	90	306	19	11
ACS355-03X-07A3-4	R1	107	364	24	14
ACS355-03X-08A8-4	R1	127	433	24	14
ACS355-03X-12A5-4	R3	161	551	52	31
ACS355-03X-15A6-4	R3	204	697	52	31
ACS355-03X-23A1-4	R3	301	1029	71	42
ACS355-03X-31A0-4	R4	408	1393	96	57
ACS355-03X-38A0-4	R4	498	1700	96	57
ACS355-03X-44A0-4	R4	588	2007	96	57

X within the type code stands for E or U.

¹⁾ BTU/hr = British Thermal Unit per hour. BTU/hr is approximately 0.293 Watts.

²⁾ Frame size R0 with free convection cooling.

Free space requirements

Enclosure type	Space above mm	Space below mm	Space on left/right mm
All frame sizes	75	75	0
IP66/67 enclosure	75	75	20

Fuses

Standard fuses can be used with ABB general machinery drives. For input fuse connections see table below.

Selection table

Type code	Frame size	IEC Fuses		UL Fuses	
		[A]	Fuse type ^{*)}	[A]	Fuse type ^{*)}
1-phase supply voltage 200 to 240 V units					
ACS355-01X-02A4-2	R0	10	gG	10	UL class T
ACS355-01X-04A7-2	R1	16	gG	20	UL class T
ACS355-01X-06A7-2	R1	16/20 ¹⁾	gG	25	UL class T
ACS355-01X-07A5-2	R2	20/25 ¹⁾	gG	30	UL class T
ACS355-01X-09A8-2	R2	25/35 ¹⁾	gG	35	UL class T
3-phase supply voltage 200 to 240 V units					
ACS355-03X-02A4-2	R0	10	gG	10	UL class T
ACS355-03X-03A5-2	R0	10	gG	10	UL class T
ACS355-03X-04A7-2	R1	10	gG	15	UL class T
ACS355-03X-06A7-2	R1	16	gG	15	UL class T
ACS355-03X-07A5-2	R1	16	gG	15	UL class T
ACS355-03X-09A8-2	R2	16	gG	20	UL class T
ACS355-03X-13A3-2	R2	25	gG	30	UL class T
ACS355-03X-17A6-2	R2	25	gG	35	UL class T
ACS355-03X-24A4-2	R3	63	gG	60	UL class T
ACS355-03X-31A0-2	R4	80	gG	80	UL class T
ACS355-03X-46A2-2	R4	100	gG	100	UL class T
3-phase supply voltage 380 to 480 V units					
ACS355-03X-01A2-4	R0	10	gG	10	UL class T
ACS355-03X-01A9-4	R0	10	gG	10	UL class T
ACS355-03X-02A4-4	R1	10	gG	10	UL class T
ACS355-03X-03A3-4	R1	10	gG	10	UL class T
ACS355-03X-04A1-4	R1	16	gG	15	UL class T
ACS355-03X-05A6-4	R1	16	gG	15	UL class T
ACS355-03X-07A3-4	R1	16	gG	20	UL class T
ACS355-03X-08A8-4	R1	20	gG	25	UL class T
ACS355-03X-12A5-4	R3	25	gG	30	UL class T
ACS355-03X-15A6-4	R3	35	gG	35	UL class T
ACS355-03X-23A1-4	R3	50	gG	50	UL class T
ACS355-03X-31A0-4	R4	80	gG	80	UL class T
ACS355-03X-38A0-4	R4	100	gG	100	UL class T
ACS355-03X-44A0-4	R4	100	gG	100	UL class T

X within the type code stands for E or U.

^{*)} According to IEC-60269 standard.

¹⁾ If 50% overload capacity is needed, use the bigger fuse alternative.

Control connections

ACS355 - 01E - 02A4 - 2 + A123

Application macros

Application macros are preprogrammed parameter sets. While starting up the drive, the user typically selects one of the macros that is best suited for the application. The diagram below gives an overview of ACS355 control connections and shows the default I/O connections for the ABB standard macro.

- 3-wire macro
- Alternate macro
- Motor potentiometer macro
- Hand/auto macro
- PID control macro

ABB general machinery drives have seven standard macros:

- ABB Standard macro
- Torque control macro

In addition to the standard macros the user can create three user macros. The user macro allows the user to save the parameter settings for later use.

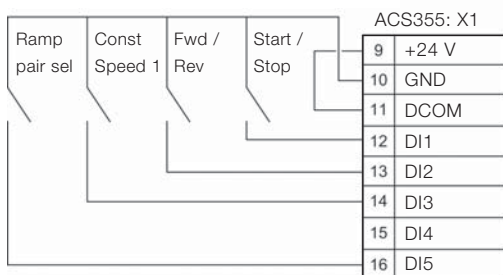
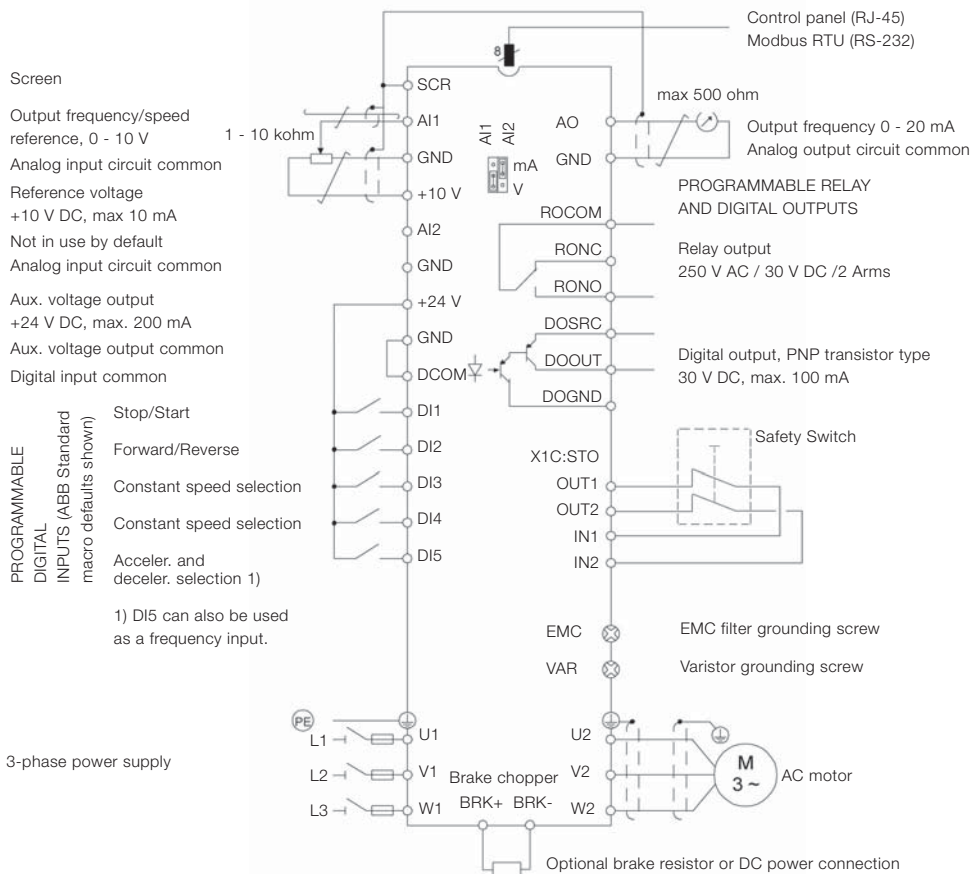

Sinking DI configuration (NPN connected).

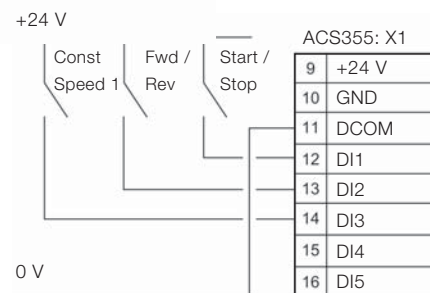

Sourcing DI configuration (PNP connected) with external power supply.

Options

ACS355 - 01E - 02A4 - 2 + A123

How to select options

The options shown in the table are available within the ACS355 range. The ordering code, which is shown in the second column, replaces the A123 in the type code above. You can order as many options as required, simply by extending the code as necessary.

Options	Ordering code	Description	Model	Availability	
				IP20 drive	IP66/67 drive
Protection class	¹⁾	NEMA 1/UL type 1 (R0, R1, R2)	MUL1-R1	■	-
	¹⁾	NEMA 1/UL type 1 (R3)	MUL1-R3	■	-
	¹⁾	NEMA 1/UL type 1 (R4)	MUL1-R4	■	-
	B063	IP66/IP67/UL type 4X enclosure		-	■
Control panel (choose one option only)	J400	Assistant control panel	ACS-CP-A	□	●
	J404	Basic control panel	ACS-CP-C	□	-
Panel mounting kit	¹⁾	Panel mounting kit	ACS/H-CP-EXT	□	-
	¹⁾	Panel holder mounting kit	OPMP-01	□	-
Potentiometer	J402	Potentiometer	MPOT-01	□	-
Fieldbus (choose one option only)	K451	DeviceNet	FDNA-01	□	□
	K454	PROFIBUS DP	FPBA-01	□	□
	K457	CANopen	FCAN-01	□	□
	K458	ModBus RTU	FMBA-01	□	□
	K466	Ethernet IP / Modbus TCP/IP	FENA-01	□	□
	K452	LonWorks	FLON-01	□	□
	K469	EtherCat	FECA-01	□	□
¹⁾	RS-485/Modbus	FRSA-00	□	□	
Extension modules (choose one option only)	L502	Speed encoder module	MTAC-01	□	-
	L511	Relay output module	MREL-01	□	-
	G406	Auxiliary power extension module	MPOW-01	□	-
Remote monitoring	¹⁾	Ethernet adapter	SREA-01	□	□
Connection options	H376	Cable gland kit (IP66/IP67/UL Type 4X)		-	□
	F278	Input switch kit		-	□
Pressure compensation	C169	Pressure compensation valve		-	□
Tools	¹⁾	FlashDrop tool	MFDT-01	□	□
	¹⁾	DriveWindow Light 2	DriveWindow Light 2	□	□
External options	¹⁾	Input chokes		□	□ ¹⁾
	¹⁾	EMC filters		□	□ ¹⁾
	¹⁾	Braking resistors		□	□ ¹⁾
	¹⁾	Output chokes		□	□ ¹⁾

● = standard

■ = product variant

□ = option, external

- = not available

¹⁾ = Ordering with a separate MRP code number.

¹⁾ External options not available in IP66/IP67/UL Type 4X protection class.

Options Interface

ACS355 - 01E - 02A4 - 2 + A123

User interfaces

Panel cover

The purpose of the panel cover is to protect the drive's connection surfaces. The ACS355 drive is delivered with a panel cover as standard. In addition there are two alternative control panels available as options.

Basic control panel

The basic control panel features a single line numeric display. The panel can be used to control the drive, set the parameter values or copy them from one drive to another.

Assistant control panel

The assistant control panel features a multilingual alphanumeric display for easy drive programming. The control panel has various assistants and an built-in help function to guide the user. It includes a real time clock, which can be used during fault logging and in controlling the drive, such as start/stop. The control panel can be used for copying parameters for back up or for downloading to another drive. A large graphical display and soft keys make it extremely easy to navigate. The drive with IP66/IP67 enclosure has the assistant control panel as standard.

Potentiometer

Potentiometer MPOT-01 with two switches: start/stop and forward/reverse. Polarity is selected with DIP switches. No external power source is needed for the potentiometer.

Panel mounting kits

To attach the control panel to the outside of a larger enclosure, two panel mounting kits are available. A simple and cost-efficient installation is possible with the ACS/H-CP-EXT kit, while the OPMP-01 kit provides a more user-friendly solution, including a panel platform that enables the panel to be removed in the same way as a drive-mounted panel. The panel mounting kits include all hardware required, including 3 m extension cables and installation instructions.



Panel cover (included as standard)



Basic control panel



Assistant control panel



Potentiometer



Panel holder mounting kit OPMP-01

Options Interface

ACS355 - 01E - 02A4 - 2 + A123



Fieldbus module

NEMA 1/UL type 1 kit

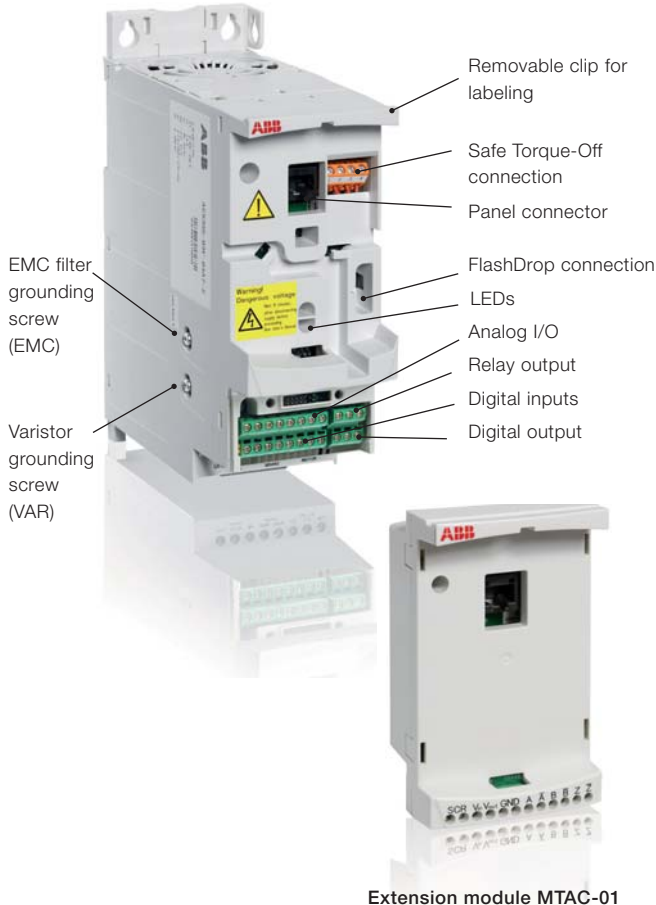

Extension module MTAC-01

Machine interfaces

The plug-in fieldbus modules bring connectivity to major automation systems. A single twisted pair cable avoids large amounts of conventional cabling, thereby reducing costs and increasing system reliability.

ACS355 supports the following fieldbus options:

- PROFIBUS DP
- CANopen
- DeviceNet
- Modbus RTU
- Ethernet IP / Modbus TCP/IP
- LonWorks
- EtherCat

Extension modules

MREL-01

ACS355 has one relay output as standard. The optional MREL-01 module offers three additional relay outputs, which can be configured for different functions with parameters.

MTAC-01

The optional MTAC-01 module offers pulse encoder interface for speed measurement.

MPOW-01

The optional auxiliary power module MPOW-01 enables the drive control circuitry to be operated under all conditions.

Protection and installation

NEMA 1/UL Type 1 kit

The NEMA 1/UL Type 1 kit includes a connection box for finger protection, conduit tube installation, and a hood for protection against dirt and dust.

Terminal cover

The terminal cover is for protection of the I/O connections.

Clamping plates

The clamping plates are used for protection against electrical disturbances. The clamping plates with clamps are included in the drive package as standard.

Options

Software tools

A separate order line and type code is required for any of these software tool options.

DriveWindow Light 2

DriveWindow Light 2 is an easy-to-use start-up and maintenance tool for ACS355 drives. It can be used in an offline mode, which enables parameter setting at the office even before going to the actual site. The parameter browser enables viewing, editing and saving of parameters. The parameter comparison feature makes it possible to compare parameter values between the drive and saved parameter files. With the parameter subset you can create your own parameter sets. Controlling of the drive is naturally one of the features in DriveWindow Light. With this software tool, you can monitor up to four signals simultaneously. This can be done in both graphical and numerical format. Any signal can be set to stop the monitoring from a predefined level.

Sequence programming tool

DriveWindow Light 2 allows the user to visually build and manipulate sequence programming parameters that are loaded into the ACS355. The programming is done in a graphical editor which displays each sequence step as an individual block.

Sequence programming enables application specific programming. This new and easy way to preset sequences reduces the need for an external programmable logic control (PLC). In simple applications an external PLC can be left out.

Start-up wizards

Start-up wizards make the setting of parameters easy. Simply launch the wizard, select an appropriate assistant e.g. for setting analog outputs, and all parameters related to this function are shown together with help pictures.

Highlights

- Graphical sequence programming tool for ACS355
- Editing, saving and downloading parameters
- Graphical and numerical signal monitoring
- Drive control
- Start-up wizards

DriveWindow Light requirements

- Windows NT/2000/XP/Vista
- Free serial port from a PC
- Free control panel connector

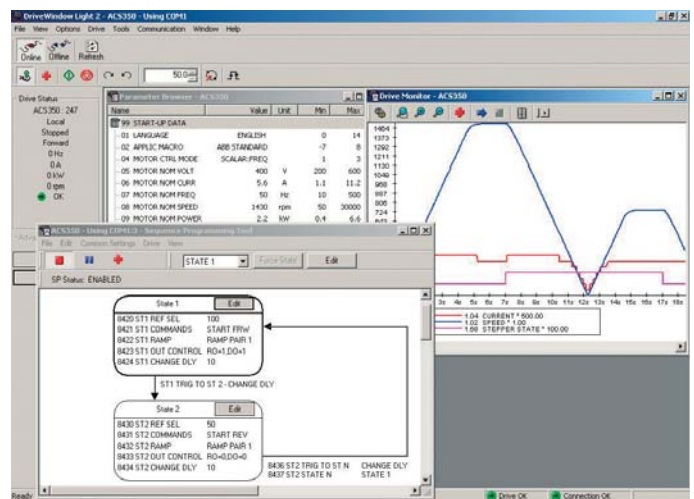

Options External

A separate order line and type code is required for any of these external options.

FlashDrop tool

FlashDrop is a powerful palm sized tool for fast and easy parameter selecting and setting. It gives the possibility to hide selected parameters to protect the machine. Only the parameters needed in the application are shown. The tool can copy parameters between two drives or between a PC and a drive. All the above can be done without a power connection to the drive – in fact, it is not even necessary to unpack the drive.

DrivePM

DrivePM (Drive parameter manager) is a tool to create, edit and copy parameter sets for the FlashDrop tool. For each parameter/group the user has a possibility to hide it, which means that the drive user does not see the parameter/group at all.

DrivePM requirements

- Windows 2000/XP/Vista
- Free serial port from a PC

FlashDrop package includes

- FlashDrop tool
- DrivePM software on a CD-rom
- User's manual in English and in pdf-format on the CD-rom
- Cable OPCA-02 for connection between the PC and FlashDrop tool
- Battery charger



Brake resistors

ACS355 is delivered with an integrated brake chopper as standard. Therefore no additional space or installation time is needed. The brake resistor is selected using the table below. For more information about the selection of brake resistors, see the ACS355 User's Manual.

Brake chopper limits and resistor selection table

Type code ACS355-	R_{min} [ohm]	P_{BRmax} [kW] [hp]		Selection table by resistor type						Braking time ¹⁾ [s]
				CBR-V / CBT-H						
				160	210	260	460	660	560	
1-phase supply voltage 200 to 240 V units										
01X-02A4-2	70	0.37	0.5	●						90
01X-04A7-2	40	0.75	1	●						45
01X-06A7-2	40	1.1	1.5	●						28
01X-07A5-2	30	1.5	2	●						19
01X-09A8-2	30	2.2	3	●						14
3-phase supply voltage 200 to 240 V units										
03X-02A4-2	70	0.37	0.5	●						90
03X-03A5-2	70	0.55	0.75	●						60
03X-04A7-2	40	0.75	1	●						42
03X-06A7-2	40	1.1	1.5	●						29
03X-07A5-2	30	1.5	2	●						19
03X-09A8-2	30	2.2	3	●						14
03X-13A3-2	30	3	4				●			16
03X-17A6-2	30	4	5				●			12
03X-24A4-2	18	5.5	7.5						●	45
03X-31A0-2	7	7.5	10						●	35
03X-46A2-2	7	11	15						●	23
3-phase supply voltage 380 to 480 V units										
03X-01A2-4	200	0.37	0.5		●					90
03X-01A9-4	175	0.55	0.75		●					90
03X-02A4-4	165	0.75	1		●					60
03X-03A3-4	150	1.1	1.5		●					37
03X-04A1-4	130	1.5	2		●					27
03X-05A6-4	100	2.2	3		●					17
03X-07A3-4	70	3	4				●			29
03X-08A8-4	70	4	5				●			20
03X-12A5-4	40	5.5	7.5				●			15
03X-15A6-4	40	7.5	10				●			10
03X-23A1-4	30	11	15					●		10
03X-31A0-4	16	15	20						●	16
03X-38A0-4	13	18.5	25						●	13
03X-44A0-4	13	22	30						●	10

X within the type code stands for E or U.

¹⁾ Braking time = Maximum allowed braking time in seconds at P_{BRmax} every 120 seconds, at 40 °C ambient temperature

Ratings by resistor type	CBR-V 160	CBR-V 210	CBR-V 260	CBR-V 460	CBR-V 660	CBT-H 560
Nominal power [W]	280	360	450	790	1130	2200
Resistance [ohm]	70	200	40	80	33	18

Options External

A separate order line and type code is required for any of these external options.

Input chokes

Input choke smooths the wave shape of mains current and reduces total harmonic distortion (THD). Together with the input choke, the ACS355 is designed to fulfill the requirements of the harmonics standard EN/IEC 61000-3-12. In addition, the input choke provides improved protection against mains voltage transients.

Type code ACS355-	Frame size	Input choke	I_{IN} without choke [A]	I_{IN} with choke [A]	I_{TH} [A]	L [mH]
1-phase supply voltage 200 to 240 V units						
01X-02A4-2	R0	CHK-A1	6.1	4.5	5	8.0
01X-04A7-2	R1	CHK-B1	11.4	8.1	10	2.8
01X-06A7-2	R1	CHK-C1	16.1	11	16	1.2
01X-07A5-2	R2	CHK-C1	16.8	12	16	1.2
01X-09A8-2	R2	CHK-D1	21	15	25	1.0
3-phase supply voltage 200 to 240 V units						
03X-02A4-2	R0	CHK-01	4.3	2.2	4.2	6.4
03X-03A5-2	R0	CHK-02	6.1	3.6	7.6	4.6
03X-04A7-2	R1	CHK-03	7.6	4.8	13	2.7
03X-06A7-2	R1	CHK-03	11.8	7.2	13	2.7
03X-07A5-2	R1	CHK-04	12	8.2	22	1.5
03X-09A8-2	R2	CHK-04	14.3	11	22	1.5
03X-13A3-2	R2	CHK-04	21.7	14	22	1.5
03X-17A6-2	R2	CHK-04	24.8	18	22	1.5
03X-24A4-2	R3	CHK-06	41	27	47	0.7
03X-31A0-2	R4	CHK-06	50	34	47	0.7
03X-46A2-2	R4	CHK-06	69	47	47	0.7
3-phase supply voltage 380 to 480 V units						
03X-01A2-4	R0	CHK-01	2.2	1.1	4.2	6.4
03X-01A9-4	R0	CHK-01	3.6	1.8	4.2	6.4
03X-02A4-4	R1	CHK-01	4.1	2.3	4.2	6.4
03X-03A3-4	R1	CHK-01	6	3.1	4.2	6.4
03X-04A1-4	R1	CHK-02	6.9	3.5	7.6	4.6
03X-05A6-4	R1	CHK-02	9.6	4.8	7.6	4.6
03X-07A3-4	R1	CHK-02	11.6	6.1	7.6	4.6
03X-08A8-4	R1	CHK-03	13.6	7.7	13	2.7
03X-12A5-4	R3	CHK-03	18.8	11.4	13	2.7
03X-15A6-4	R3	CHK-04	22.1	11.8	22	1.5
03X-23A1-4	R3	CHK-04	30.9	17.5	22	1.5
03X-31A0-4	R4	CHK-05	52	24.5	33	1.1
03X-38A0-4	R4	CHK-06	61	31.7	47	0.7
03X-44A0-4	R4	CHK-06	67	37.8	47	0.7

I_{IN} = Nominal input current

I_{TH} = Nominal choke thermal current

L = Choke inductance

Output chokes

Output choke decreases du/dt on the output and filters current spikes caused by voltage spikes. With an output choke it is possible to increase the motor cable length which could be otherwise limited due to a temperature increase resulting from current spikes and electromagnetic performance.

Type code ACS355-	Frame size	Output choke	Cable length [m]
1-phase supply voltage 200 to 240 V units			
01X-02A4-2	R0	ACS-CHK-B3	60
01X-04A7-2	R1	ACS-CHK-B3	100
01X-06A7-2	R1	ACS-CHK-C3	100
01X-07A5-2	R2	ACS-CHK-C3	100
01X-09A8-2	R2	ACS-CHK-C3	100
3-phase supply voltage 200 to 240 V units			
03X-02A4-2	R0	ACS-CHK-B3	60
03X-03A5-2	R0	ACS-CHK-B3	60
03X-04A7-2	R1	ACS-CHK-B3	100
03X-06A7-2	R1	ACS-CHK-C3	100
03X-07A5-2	R1	ACS-CHK-C3	100
03X-09A8-2	R2	ACS-CHK-C3	100
03X-13A3-2	R2	NOCH-0016-6x	100
03X-17A6-2	R2	NOCH-0016-6x	100
03X-24A4-2	R3	NOCH-0030-6x	100
03X-31A0-2	R4	NOCH-0030-6x	100
03X-46A2-2	R4	NOCH-0070-6x	100
3-phase supply voltage 380 to 480 V units			
03X-01A2-4	R0	ACS-CHK-B3	60
03X-01A9-4	R0	ACS-CHK-B3	60
03X-02A4-4	R1	ACS-CHK-B3	100
03X-03A3-4	R1	ACS-CHK-B3	100
03X-04A1-4	R1	ACS-CHK-C3	100
03X-05A6-4	R1	ACS-CHK-C3	100
03X-07A3-4	R1	NOCH-0016-6x	100
03X-08A8-4	R1	NOCH-0016-6x	100
03X-12A5-4	R3	NOCH-0016-6x	100
03X-15A6-4	R3	NOCH-0016-6x	100
03X-23A1-4	R3	NOCH-0030-6x	100
03X-31A0-4	R4	NOCH-0030-6x	100
03X-38A0-4	R4	NOCH-0030-6x	100
03X-44A0-4	R4	NOCH-0030-6x	100

Options External

A separate order line and type code is required for any of these external options.

EMC filters

The ACS355's internal EMC filter is designed to meet category C3 requirements of EN/IEC 61800-3 standard. External EMC filters are used to enhance the drives electromagnetic performance in conjunction with its internal filtering. Maximum motor cable length depends on required electromagnetic performance, according to the table below.

Type code ACS355-	Frame size	Filter type	Cable length ¹⁾ with external EMC filter			Cable length ¹⁾ without external EMC filter	
			C1	C2	C3	C3	C4
			[m]	[m]	[m]	[m]	[m]
1-phase supply voltage 200 to 240 V units							
01X-02A4-2	R0	RFI-11	10	30	-	30	30
01X-04A7-2	R1	RFI-12	10	30	50	30	50
01X-06A7-2	R1	RFI-12	10	30	50	30	50
01X-07A5-2	R2	RFI-13	10	30	50	30	50
01X-09A8-2	R2	RFI-13	10	30	50	30	50
3-phase supply voltage 200 to 240 V units							
03X-02A4-2	R0	RFI-32	10	30	-	30	30
03X-03A5-2	R0	RFI-32	10	30	-	30	30
03X-04A7-2	R1	RFI-32	10	30	50	30	50
03X-06A7-2	R1	RFI-32	10	30	50	30	50
03X-07A5-2	R1	RFI-32	10	30	50	30	50
03X-09A8-2	R2	RFI-32	10	30	50	30	50
03X-13A3-2	R2	RFI-33	10	30	50	30	50
03X-17A6-2	R2	RFI-33	10	30	50	30	50
03X-24A4-2	R3	RFI-34	10	30	50	30	50
03X-31A0-2	R4	RFI-34	10	30	50	30	50
03X-46A2-2	R4	RFI-34	10	30	50	30	50
3-phase supply voltage 380 to 480 V units							
03X-01A2-4	R0	RFI-32	30	30	-	30	30
03X-01A9-4	R0	RFI-32	30	30	-	30	30
03X-02A4-4	R1	RFI-32	50	50	50	30	50
03X-03A3-4	R1	RFI-32	50	50	50	30	50
03X-04A1-4	R1	RFI-32	50	50	50	30	50
03X-05A6-4	R1	RFI-32	50	50	50	30	50
03X-07A3-4	R1	RFI-32	50	50	50	30	50
03X-08A8-4	R1	RFI-32	50	50	50	30	50
03X-12A5-4	R3	RFI-33	40	40	40	30	50
03X-15A6-4	R3	RFI-33	40	40	40	30	50
03X-23A1-4	R3	RFI-33	40	40	40	30	50
03X-31A0-4	R4	RFI-34	-	30	-	30	50
03X-38A0-4	R4	RFI-34	-	30	-	30	50
03X-44A0-4	R4	RFI-34	-	30	-	30	50

¹⁾ Internal EMC filter must be connected with the EMC screw in the drive. When the filter is not connected the C4 maximum cable lengths are allowed to be used.

Low leakage current filters

Low leakage current filters are ideal for installations where residual current devices (RCD) are required and leakage current needs to be below 30 mA.

Type code ACS355-	Frame size	Filter type	Cable length ¹⁾ with LRFI filter	
			C2	[m]

Low leakage current filters, 3-phase supply voltage 400 V units

03X-01A2-4	R0	LRFI-31	10
03X-01A9-4	R0	LRFI-31	10
03X-02A4-4	R1	LRFI-31	10
03X-03A3-4	R1	LRFI-31	10
03X-04A1-4	R1	LRFI-31	10
03X-05A6-4	R1	LRFI-31	10
03X-07A3-4	R1	LRFI-32	10
03X-08A8-4	R1	LRFI-32	10

¹⁾ Internal EMC filter must be disconnected by removing the EMC screw from the drive.

EMC standards in general

EN 61800-3 (2004), product standard	EN 55011, product family standard for industrial, scientific and medical (ISM) equipment	EN 61800-3/A11 (2000), product standard
Category C1	Group 1 Class B	1 st environment, unrestricted distribution
Category C2	Group 1 Class A	1 st environment, restricted distribution
Category C3	Group 2 Class A	2 nd environment, unrestricted distribution
Category C4	Not applicable	2 nd environment, restricted distribution

Services

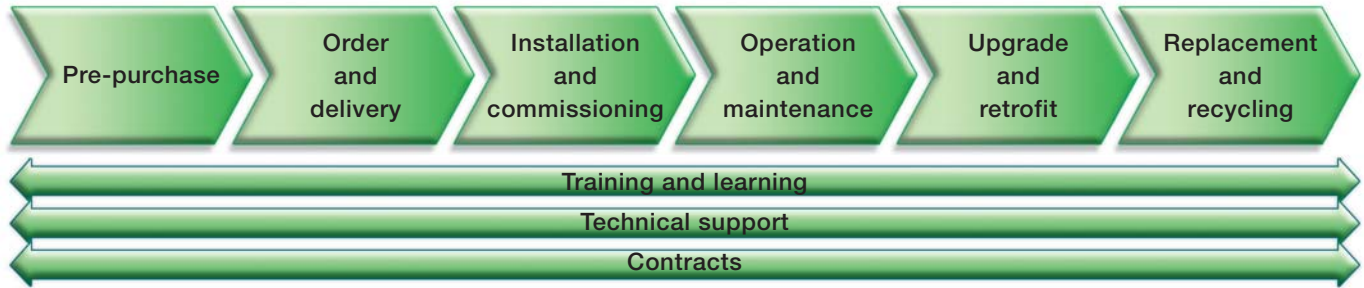

All industries face a common goal: to maximize their production output at the lowest possible cost, while maintaining the highest quality end products. One of ABB's key objectives is to maximize the uptime of its customers' processes by ensuring optimum lifetime of all ABB products in a predictable, safe and low cost manner.

The services offered for ABB low voltage drives span the entire value chain, from the moment a customer makes the first enquiry through to disposal and recycling of the drive. Throughout the value chain, ABB provides training and learning, technical support and contracts. All of this is supported by one of the most extensive global drive sales and service networks.

Maximizing return on investment

At the heart of ABB's services is its drive lifecycle management model. All services available for ABB low voltage drives are planned according to this model. For customers it is easy to see which services are available at which phase.

timing of the part replacements plus all other maintenance related actions. The model also helps the customer when deciding about upgrades, retrofits and replacements.

Drive specific maintenance schedules are also based on this four-phase model. Thus, a customer knows precisely the

Professional management of the drive's lifecycle maximizes the return on any investment in ABB low voltage drives.

ABB drive lifecycle management model



ABB follows a four-phase model for managing drive lifecycles, which brings enhanced customer support and improved efficiency.

Examples of lifecycle services are: selection and dimensioning, installation and commissioning, preventive and corrective maintenance, remote services, spare part services, training and learning, technical support, upgrade and retrofit, replacement and recycling.

Notes

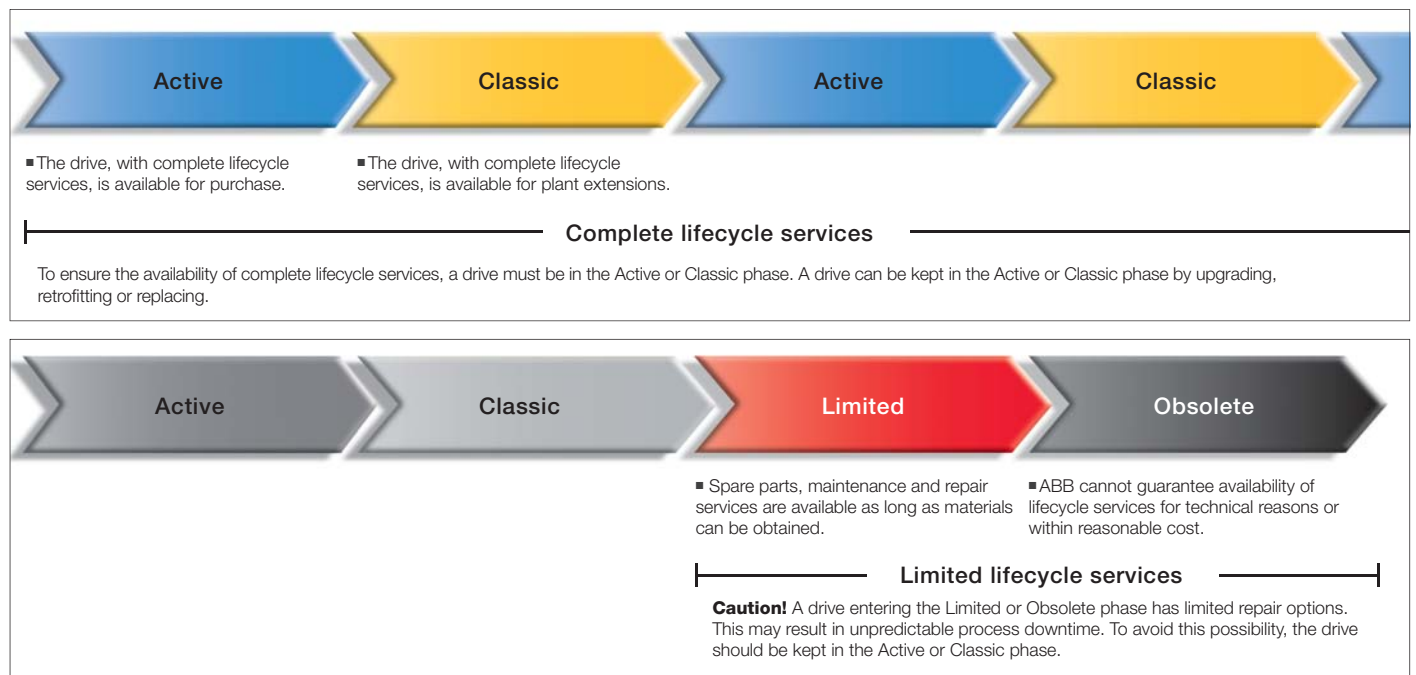
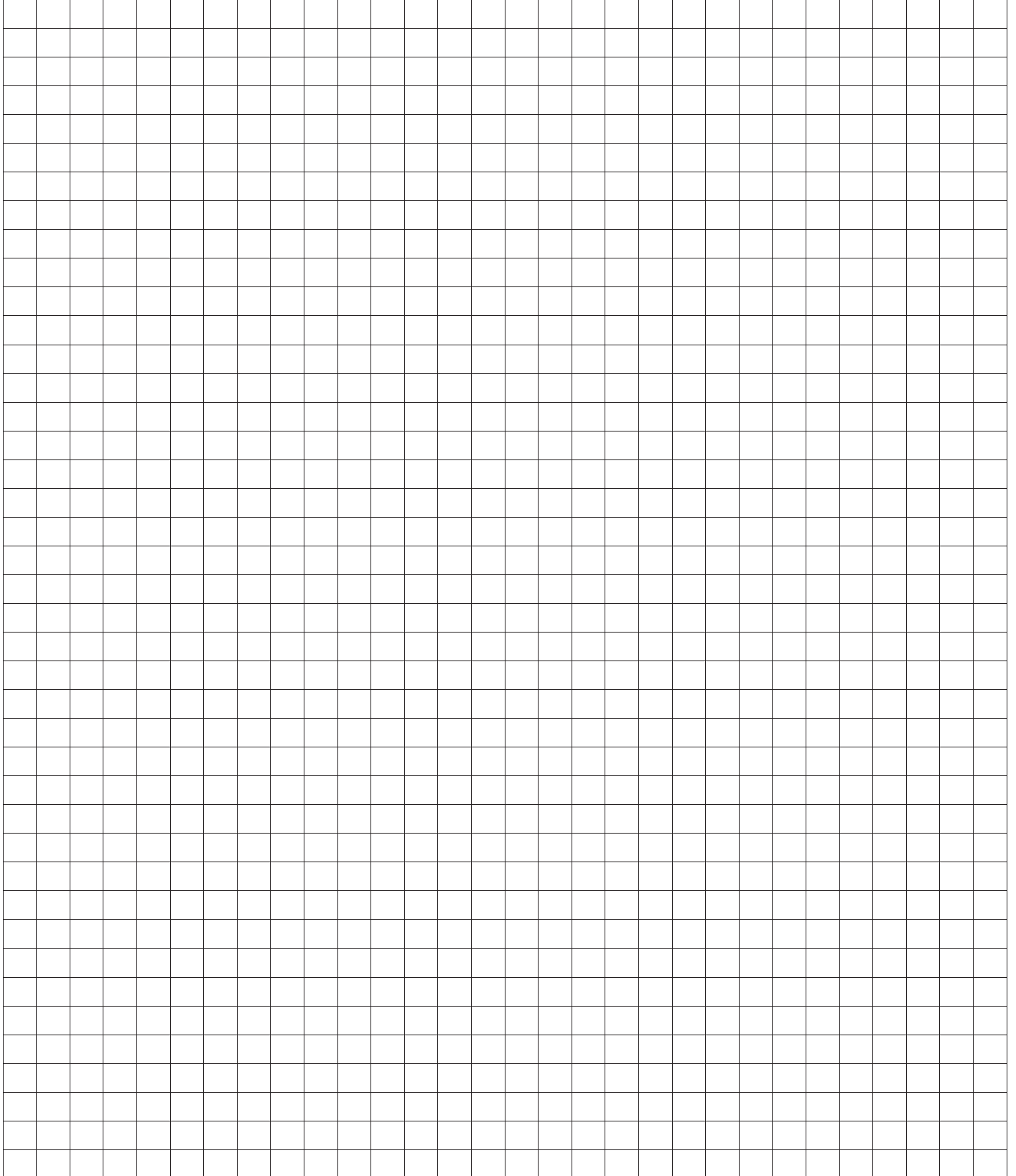

Contact us

www.abb.com/drives
www.abb.com/drivespartners

© Copyright 2009 ABB. All rights reserved.
Specifications subject to change without notice.

3AUA0000068669 REV A EN 9.11.2009 #14688